

- NOTES. 1 THIS PRODUCT IS PACKED SEPARATELY BY THE TYPES OF PARTS EXCEPT JACK UNIT .
2. RECOMMENDED CABLE IS TAIYO CABLE TECH CO.,LTD. E67647-WH AWM 20276 VW-1.  
PLEASE REFER TO THE TECHNICAL SPECIFICATION SHEET ETAD-E3166-00 ABOUT CABLE ASSEMBLY METHOD.

NO.	MATERIAL	FINISH .	REMARKS	NO.	MATERIAL	FINISH .	REMARKS
3	LCP	BLACK.	UL94V-0	7	PC	BLACK.	UL94V-0
2	PA	BLACK.	UL94V-0	6	STAINLESS STEEL	NICKEL 2 μm min.	
1	COPPER ALLOY	CONTACT AREA	: GOLD 0.2 μm min.	5	STAINLESS STEEL	NICKEL 2 μm min.	
		LEAD AREA	: GOLD 0.03 μm min.	4	STAINLESS STEEL	NICKEL 2 μm min.	
		UNDER PLATING	: NICKEL 2 μm min.				

  

UNITS mm		SCALE 2 : 1	COUNT 2	DESCRIPTION OF REVISIONS DIS-E-00001172	DESIGNED P. EKSOURIYA	CHECKED NM. NISHIMATSU	DATE 17. 09. 20
HIROSE ELECTRIC CO., LTD.				APPROVED : RI. TAKAYASU 17. 05. 10	DRAWING NO. EDC-129407-00-00		
				CHECKED : NM. NISHIMATSU 17. 05. 10	PART NO. IX40-A-8P-JC(7.1)		
				DESIGNED : P. EKSOURIYA 17. 05. 10	CODE NO. CL251-0015-0-00		
				DRAWN : P. EKSOURIYA 17. 05. 10	1/2		

1 PACKING COMPOSITION

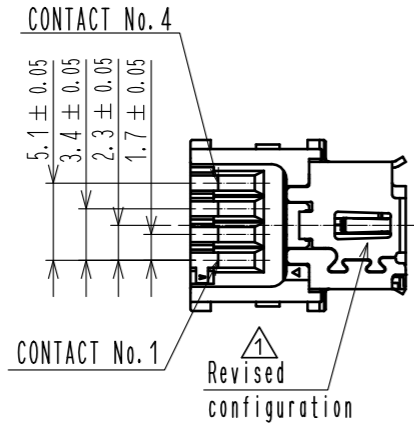

JACK UNIT

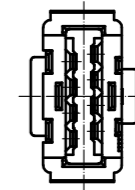
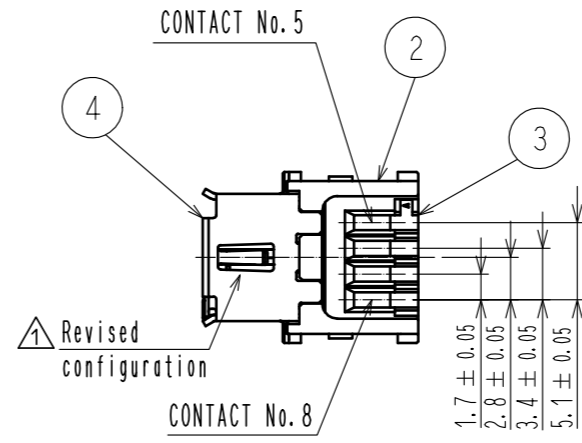
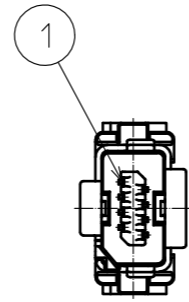

SHIELD CASE A (7.1)

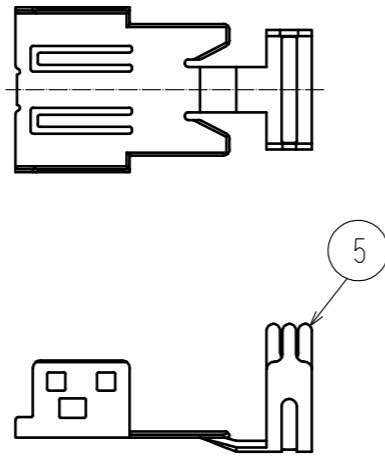

SHIELD CASE B

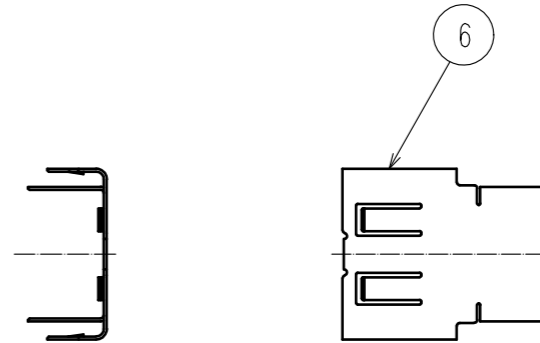

COVER CASE A (7.1)

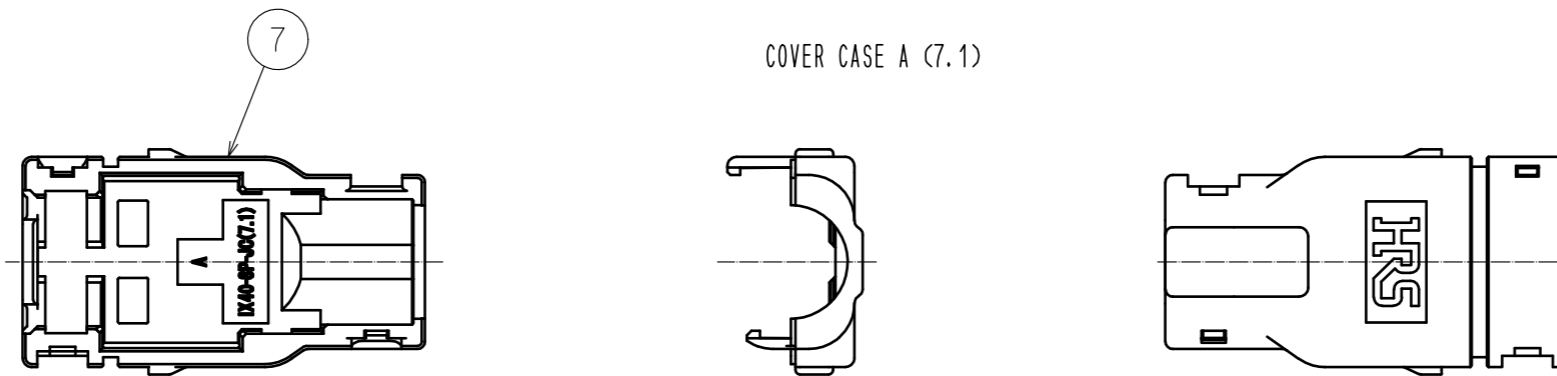

<b>HRS</b>	DRAWING NO.	EDC-129407-00-00	
	PART NO.	IX40-A-8P-JC(7.1)	
	CODE NO.	CL251-0015-0-00	